

Tizian 160

162×97×63 cm
220 l

AQUATOR

DESIGN BY AQUATOR 2008



Tizian 160 belongs to Aquator's "Sea Stone" collection and exhibits an elegant symbiosis of geometry and plastic.

FEATURES

- Massage with the same amount of power as a therapeutic tub, which is based on the experience obtained from development, production and extensive use in medical institutions.
- Extremely comfortable position + armrests.
- Special pillow ensures the neck muscles are relaxed in every position.
- Spine protected from strong, direct hydro-massage.
- Aquator Touch-screen. Unique driving system, which makes using the various massage baths more comprehensive, precise and delicate. Extremely comfortable to use.
- Price includes all possible massage components (back, side, hand and foot massage). There are 26 hydro-jets and 12 air-jets in total.
- Only top quality components and materials are used in production (Koller - Austria, Lucite - Great Britain, Röhm-Degussa - Germany).
- DME Award 2007 (Design Management Europe Award 2007).

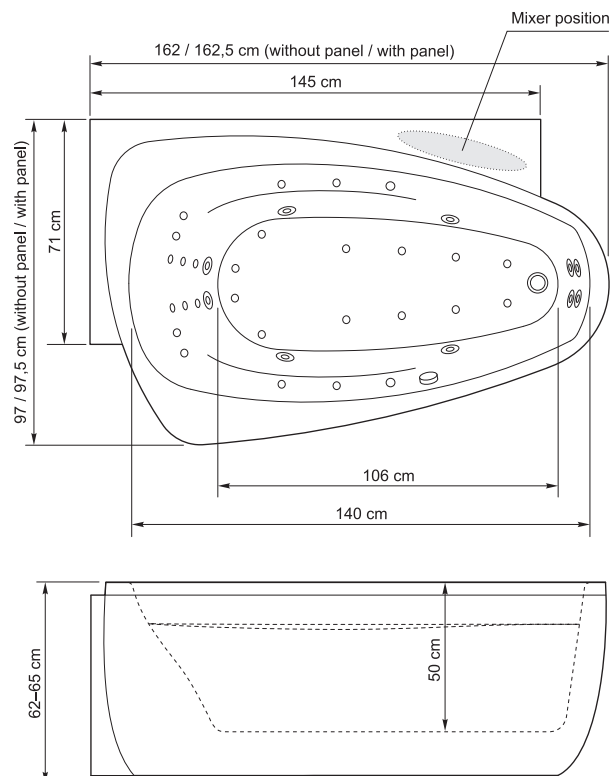

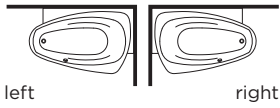

left

right

Tizian 160

COMBI POWER 6752/6762

Pneumatic control system

Side massage
Back massage
Arm massage
Hand massage
Foot massage
Air massage
Bath

Pump	2
Power (kW)	3,0
Micro-jets	• 16
Midi-jets	• 10
Air-jets	• 12

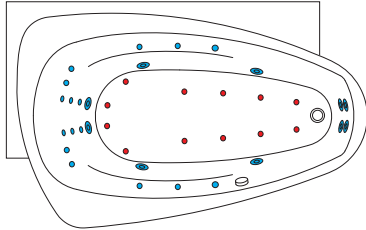

COMBI 675/676

Pneumatic control system

Side massage
Back massage
Foot massage
Air massage
Bath

Pump	1
Power (kW)	2,3
Micro-jets	• 6
Midi-jets	• 8
Air-jets	• 12

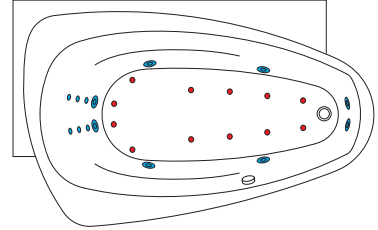

HYDRO POWER 4752/4762

Pneumatic control system

Side massage
Back massage
Arm massage
Hand massage
Foot massage
Bath

Pump	2
Power (kW)	2,2
Micro-jets	• 16
Midi-jets	• 10
Air-jets	-

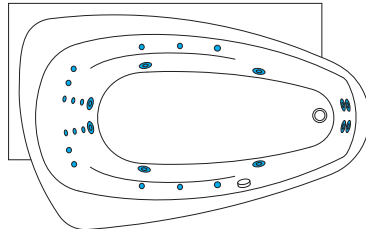

HYDRO 475/476

Pneumatic control system

Side massage
Back massage
Foot massage
Bath

Pump	1
Power (kW)	1,5
Micro-jets	• 6
Midi-jets	• 8
Air-jets	-

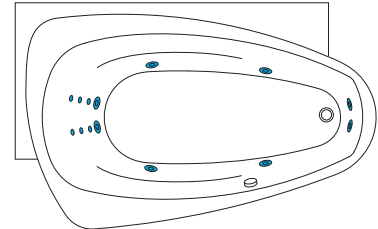

AERO 375/376

Pneumatic control system

Air massage
Bath

Pump	-
Power (kW)	0,8
Micro-jets	-
Midi-jets	-
Air-jets	• 12

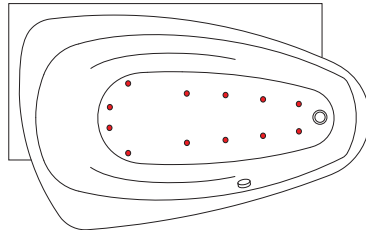

BATH 275/276

Bathtub
Frame
Siphon (drain and overflow)

Pump	-
Power (kW)	-
Micro-jets	-
Midi-jets	-
Air-jets	-

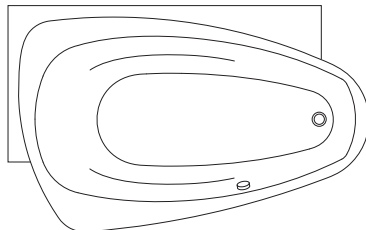

ADDITIONAL EQUIPMENT

- 075/076 Front panel
- 803 Control system "Aquator Touch-Screen"
- 802 Electronic switching
- 8202 Colour-light therapy with STOP function
- 8201 Colour-light therapy
- 820 Underwater light
- 808/8081 Water heater 1,5 kW / 3,0 kW
- 809 Air heater for blower 230 W
- 807 Air ozonator for blower
- 841/8412 Headrest "NEPTUN" black/white
- 843 Headrest "MARE"
- 856 Cascade Cristina
- 858 Bath filling via special overflow

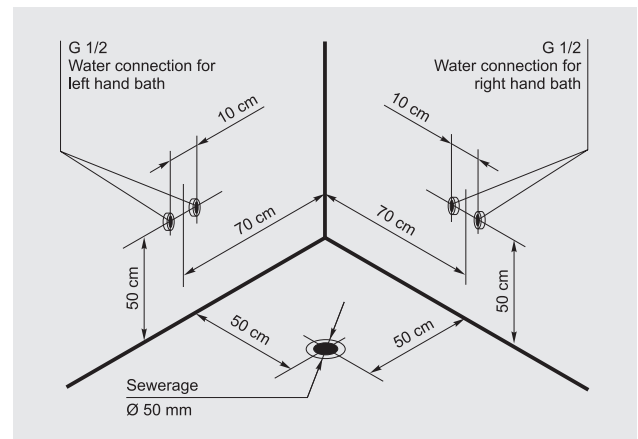

BATH LEGS POSITIONS

